

# S- 7200 PENCERE TİPLERİ

**TİP 1**

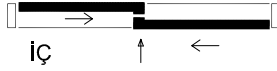
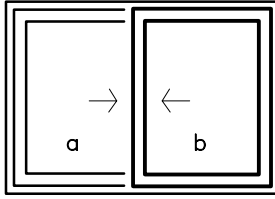

NOT : "a" ve "b" kanat dış yüzeyleri iç mahalden silinebilir.

**TİP 2**

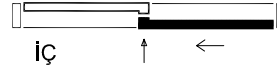
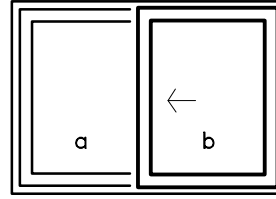

NOT : "b" kanat camının dış yüzeyinin "a" kanadı tarafında kalan yarısı sadece dışarıdan silinebilir.

**TİP 3**

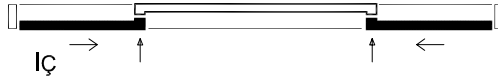
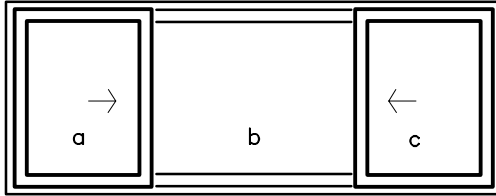

NOT : "a" ve "c" kanat camları dış yüzeylerinin "b" kanadı tarafında kalan kısımları dışarıdan silinebilir.

**TİP 4**

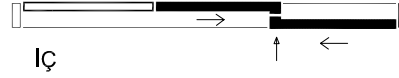
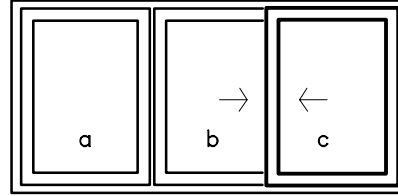

NOT : "a, b ve c" kanat camları dış yüzeyleri iç mahalden silinebilir.

**TİP 5**

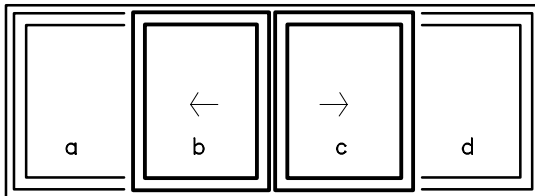

NOT : "a, b, c ve d" kanat camları dış yüzeyleri iç mahalden silinebilir.

S-7200		
KANAT İMALAT SINIRI	GENİŞLİK	YÜKSEKLİK
MIN	500	800
MAX	800	1200

TEKCAM

S-7200		
KANAT İMALAT SINIRI	GENİŞLİK	YÜKSEKLİK
MIN	500	800
MAX	700	1200

ÇİFTCAM

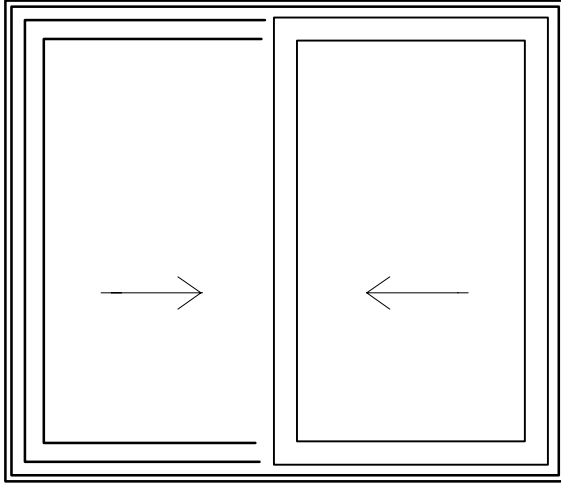
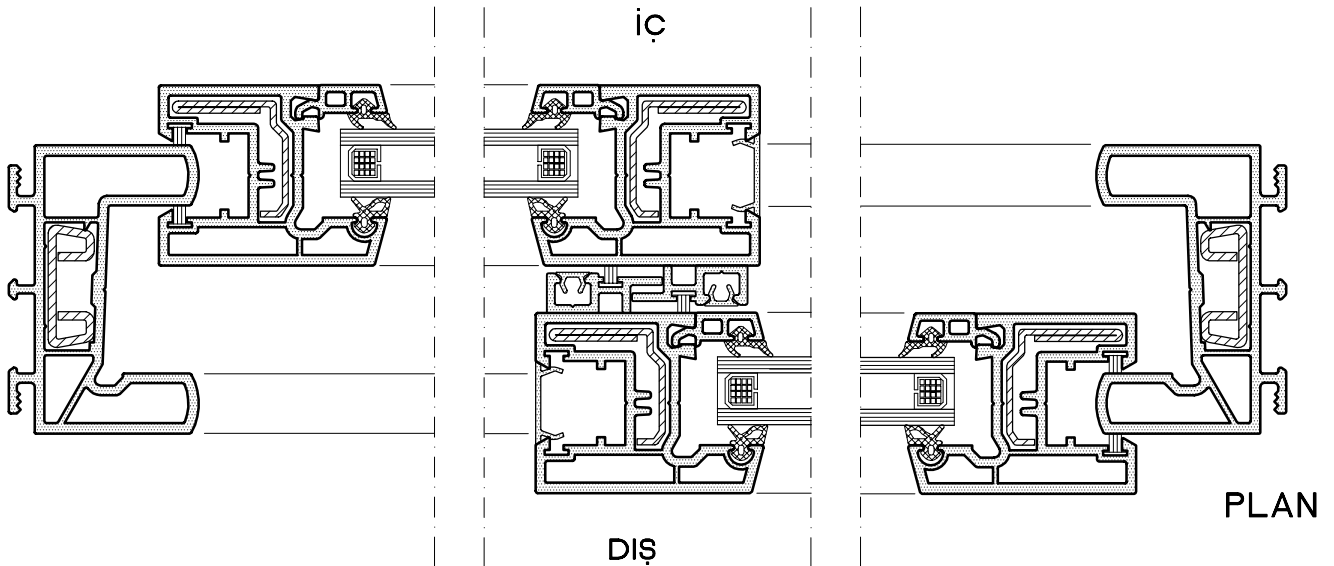
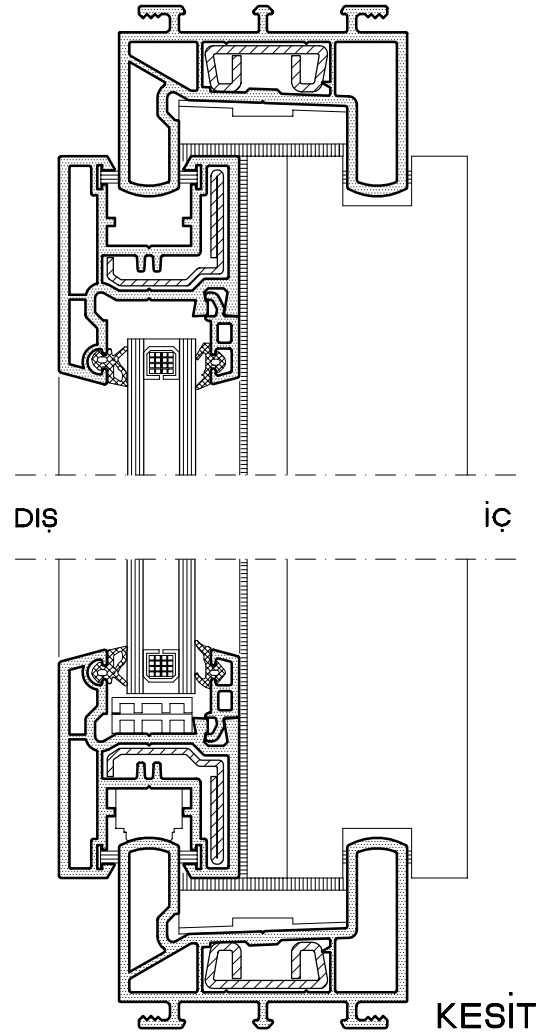
**S- 7200 PENCERE SİSTEM DETAYI****DIŞ GÖRÜNÜŞ**

# S- 7700 PENCERE TİPLERİ

**TİP 1**

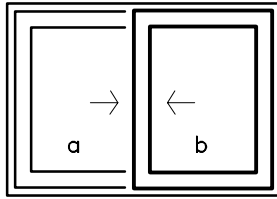

NOT : "a" ve "b" kanat dış yüzeyleri iç mahalden silinebilir.

**TİP 2**

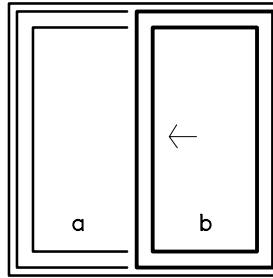

NOT : "b" kanat camının dış yüzeyinin "a" kanadı tarafında kalan yarısı sadece dışarıdan silinebilir.

**TİP 2-A**

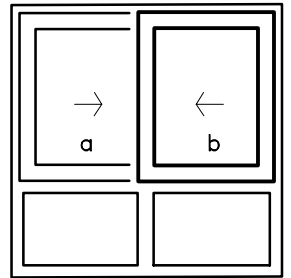

**TİP 3**

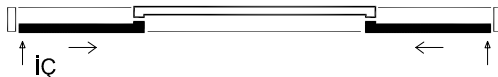
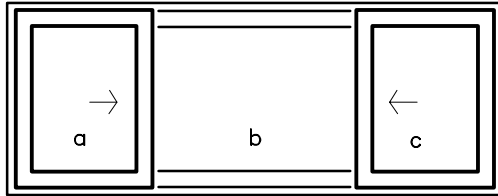

NOT : "a" ve "c" kanat camları dış yüzeylerinin "b" kanadı tarafında kalan kısımları dışarıdan silinebilir.

**TİP 4**

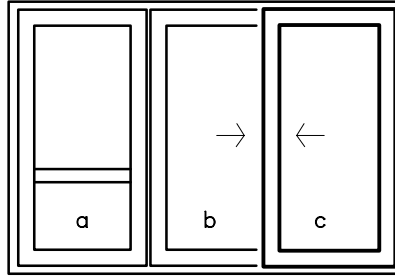

NOT : "a, b ve c" kanat camları dış yüzeyleri iç mahalden silinebilir.

**TİP 5**

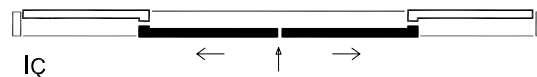
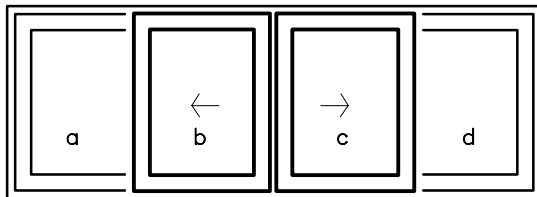

NOT : "a, b, c ve d" kanat camları dış yüzeyleri iç mahalden silinebilir.

**TİP 6**

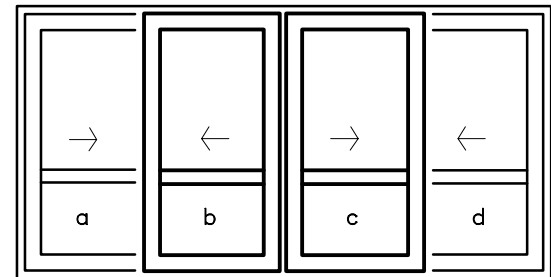

NOT : "a, b, c ve d" kanat camları dış yüzeyleri iç mahalden silinebilir.

S-7700		
KANAT İMALAT SINIRI	GENİŞLİK	YÜKSEKLİK
MIN	600	800
MAX	1200	2200

TEKCAM

S-7700		
KANAT İMALAT SINIRI	GENİŞLİK	YÜKSEKLİK
MIN	600	800
MAX	1100	2200

ÇİFTCAM

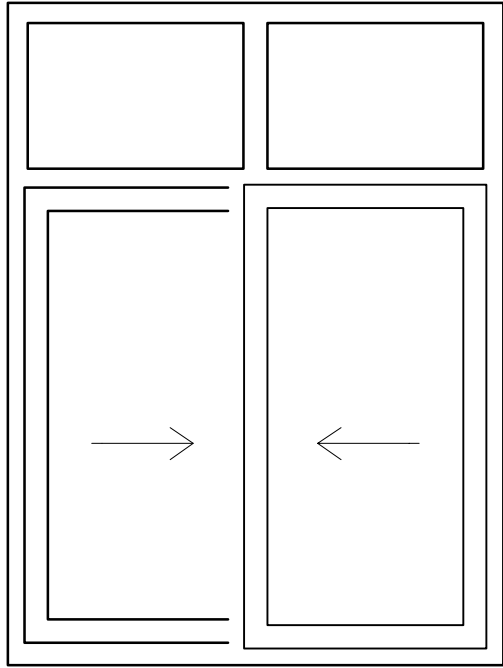
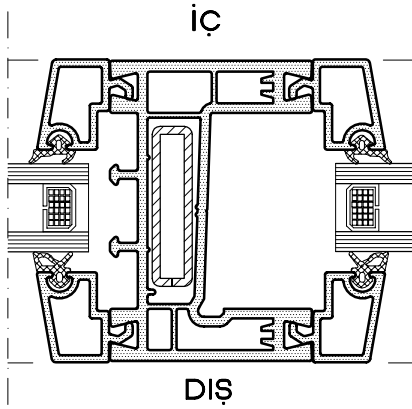
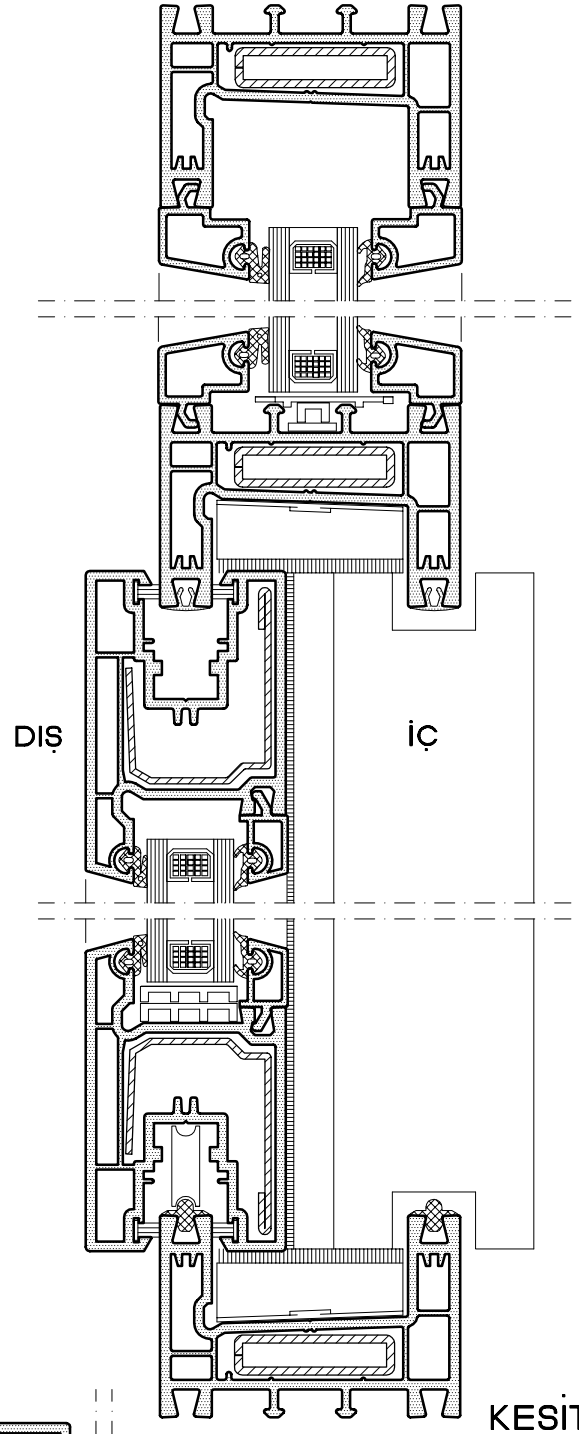
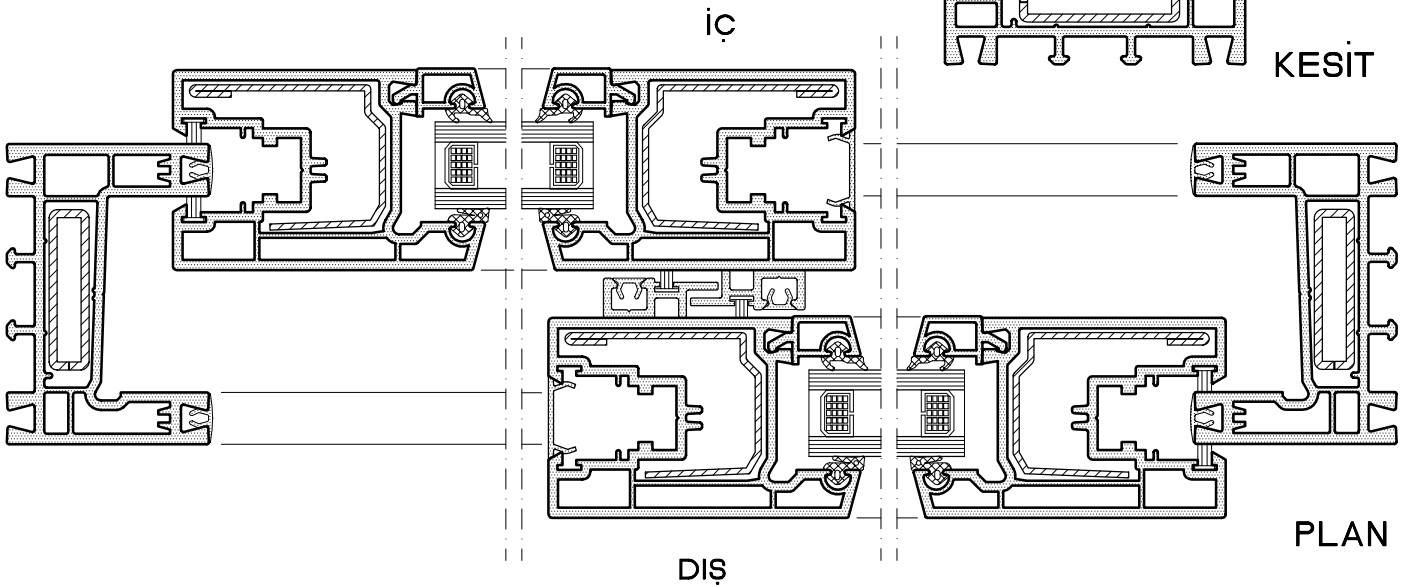
**S- 7700 PENCERE SİSTEM DETAYI****DIŞ GÖRÜNÜŞ****SABİT ORTAKAYIT DETAYI****KESİT****PLAN**

## S- 9500 PENCERE TİPLERİ

TİP 1

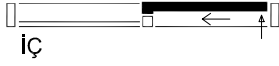
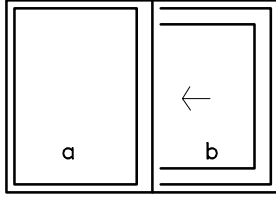

İÇ

NOT: "a" sabit camının dış yüzeyi sadece dışarıdan silinebilir.

TİP 2

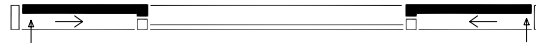
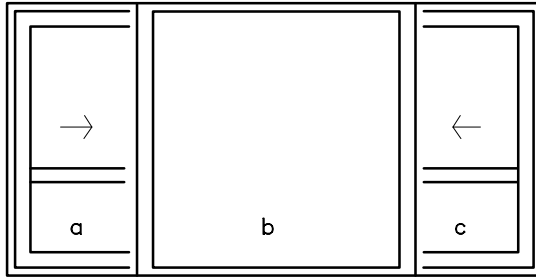

İÇ

NOT: "b" sabit camının dış yüzeyi sadece dışarıdan silinebilir.

TİP 3

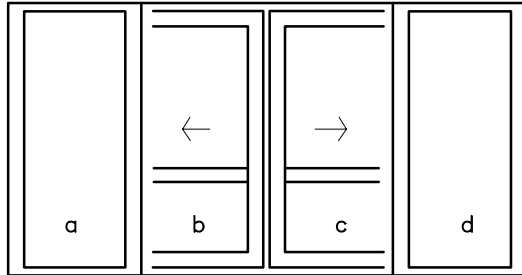

İÇ

NOT: "a, d" sabit camlarının dış yüzeyi sadece dışarıdan silinebilir.

S-9500		
KANAT İMALAT SINIRI	GENİŞLİK	YÜKSEKLİK
MİN	600	800
MAX	1200	2200

TEKCAM

S-9500		
KANAT İMALAT SINIRI	GENİŞLİK	YÜKSEKLİK
MİN	600	800
MAX	1100	2200

ÇİFTCAM

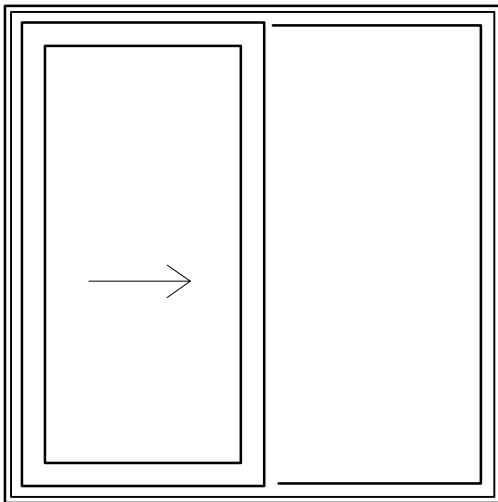
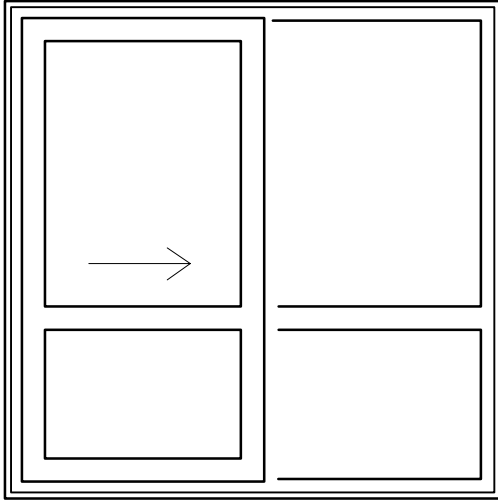
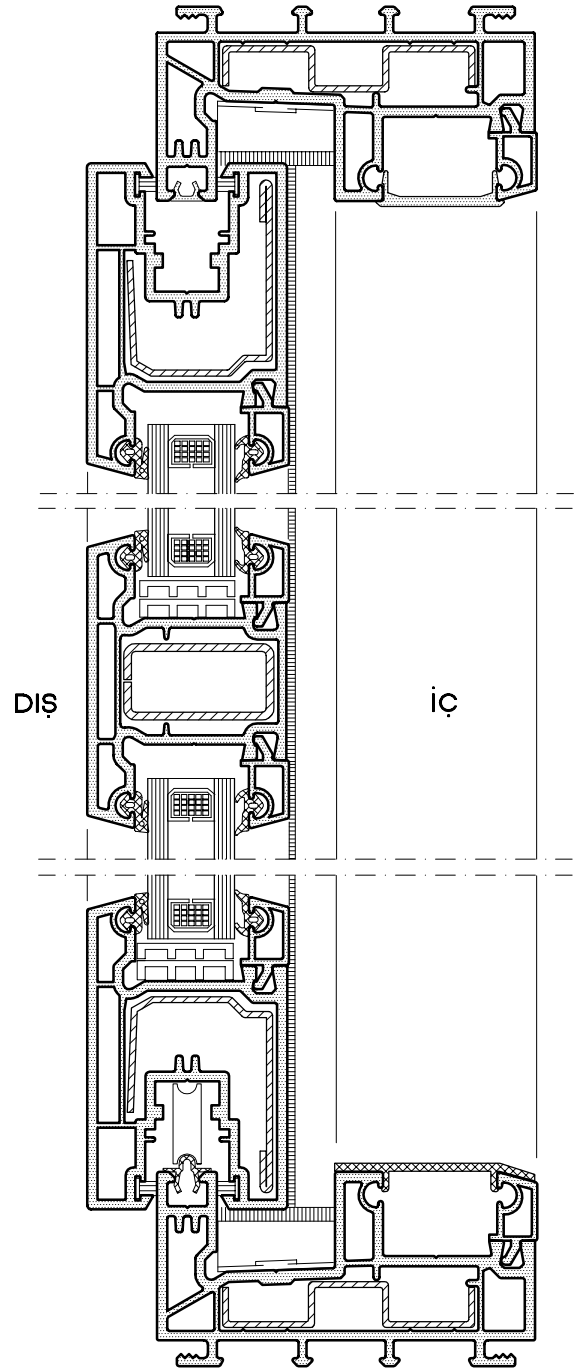
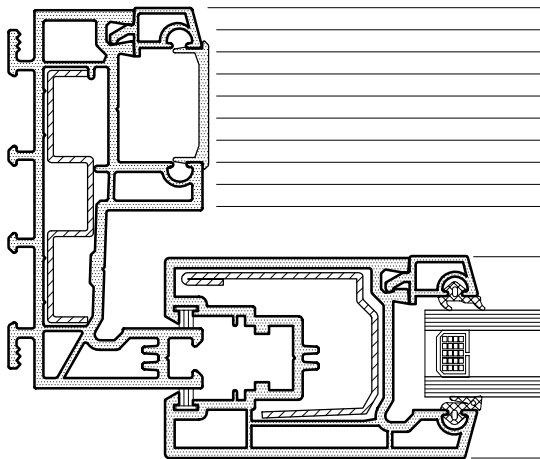
**S- 9500 PENCERE SİSTEM DETAYI****DIŞ GÖRÜNÜŞ****DIŞ****iç****KESİT****DIŞ****PLAN**