

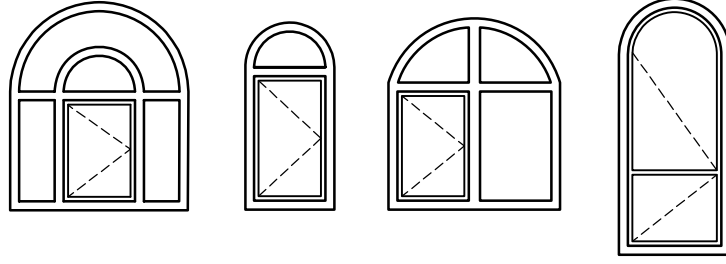



KEMERLİ PENCERE BÜKÜM ÖLÇÜLERİ

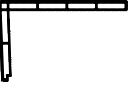
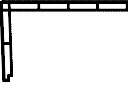

PROFİL ADI	KOMPLE BÜKÜM	KAYNAKLI BÜKÜM	BÜKÜM ÇAPI MİN - MAX (mm)
 <ul style="list-style-type: none"> • CAM ÜSTÜ YAPIŞTIRMA ÇİTASI • KAPLAMALI CAM ÜSTÜ YAPIŞTIRMA ÇİTASI 	X	X	600-1800
 <ul style="list-style-type: none"> • PERVAZ-80 PR. • KAPLAMALI PERVAZ-80 PR. 		X	600-1800
 <ul style="list-style-type: none"> • PERVAZ-120 PR. • KAPLAMALI PERVAZ-120 PR. 		X	600-1800
 <ul style="list-style-type: none"> • CITA-22 PR. • KAPLAMALI CITA-22 PR. 	X	X	600-1800
 <ul style="list-style-type: none"> • CITA-26 PR. • KAPLAMALI CITA-26 PR. 	X	X	600-1800
 <ul style="list-style-type: none"> • KASA-62/5 PR. • KAPLAMALI KASA-62/5 PR. 	X	X	600-1800
 <ul style="list-style-type: none"> • ORTAKAYIT-82/5 PR. • KAPLAMALI ORTAKAYIT-82/5 PR. 	X	X	600-1800
 <ul style="list-style-type: none"> KASA - 62/5 / KANAT - 57/5 PR. KAPLAMALI KASA - 62/5 / KANAT - 57/5 PR. 	X	X	600-1350
 <ul style="list-style-type: none"> KASA - 62/5 / KAPI- 83/4 PR. KAPLAMALI KASA - 62/5 / KAPI - 83/4 PR. 	X	X	600-1350
 <ul style="list-style-type: none"> KASA - 62/5 / D.A.KAPI - 105/4 PR. KAPLAMALI KASA - 62/5 / D.A. KAPI - 105/4 PR. 	X	X	600-1350

KOMPLE KEMERLİ PENCERE :

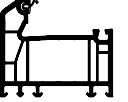
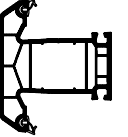
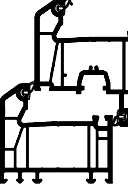
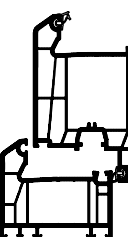
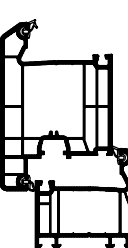
BÜKME BOYU : $2H+L=5.5$ metreyi geçmemelidir.

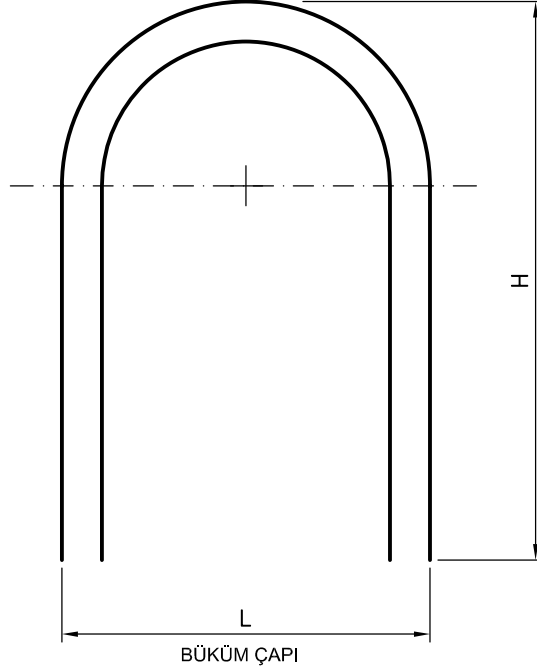

KAYNAKLI KEMERLİ PENCERE :

